

# Little Red Riding Hood Number Puzzles

Created by Deirdre Smith of JDaniel4's Mom



Terms of Use: Remember that all of my worksheets are for personal use. You cannot claim these worksheets or sell them as your own.

All the worksheets are the property of JDaniel4sMom.com

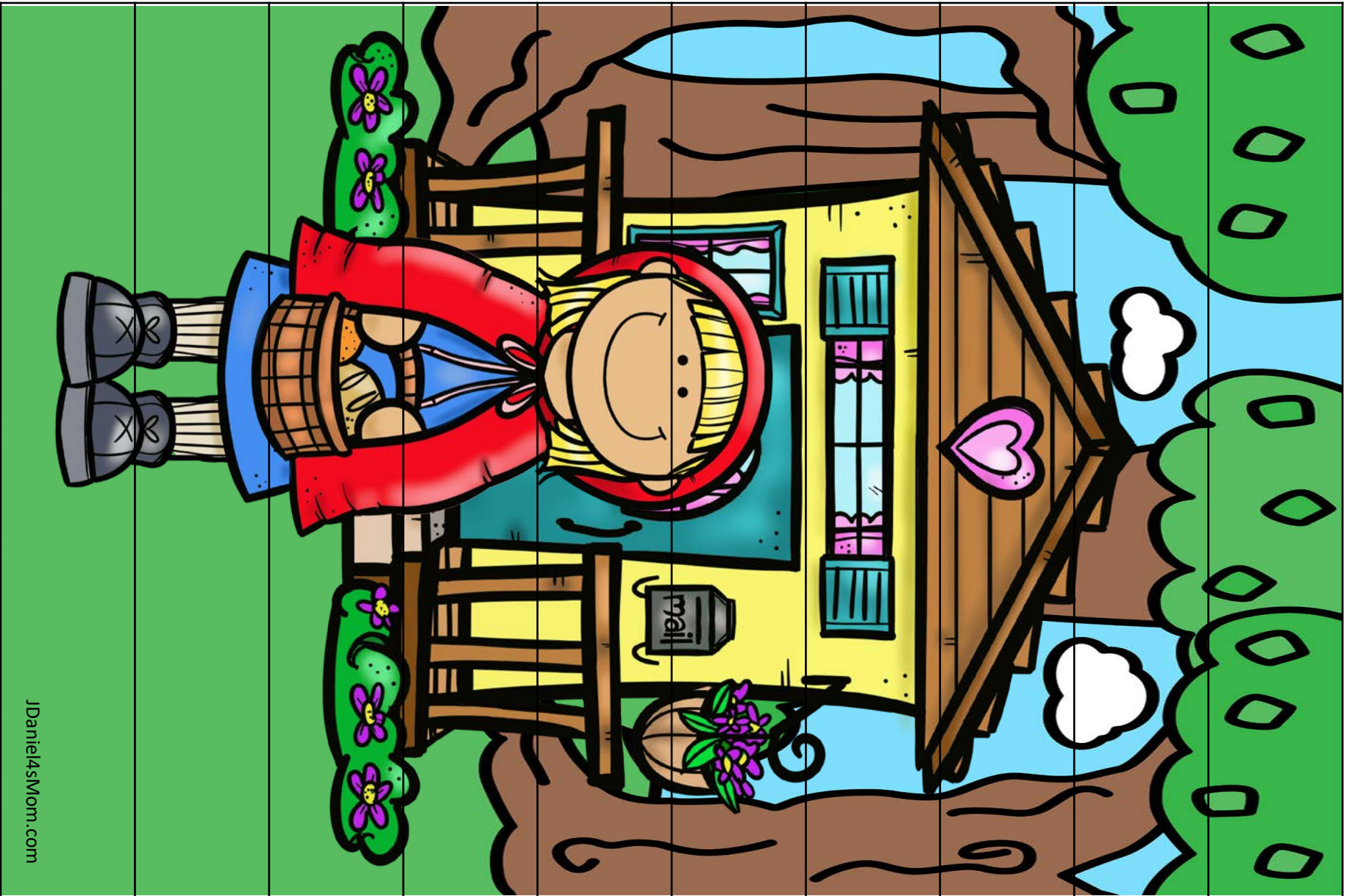

1

2

3

4

5

6

7

8

9

10

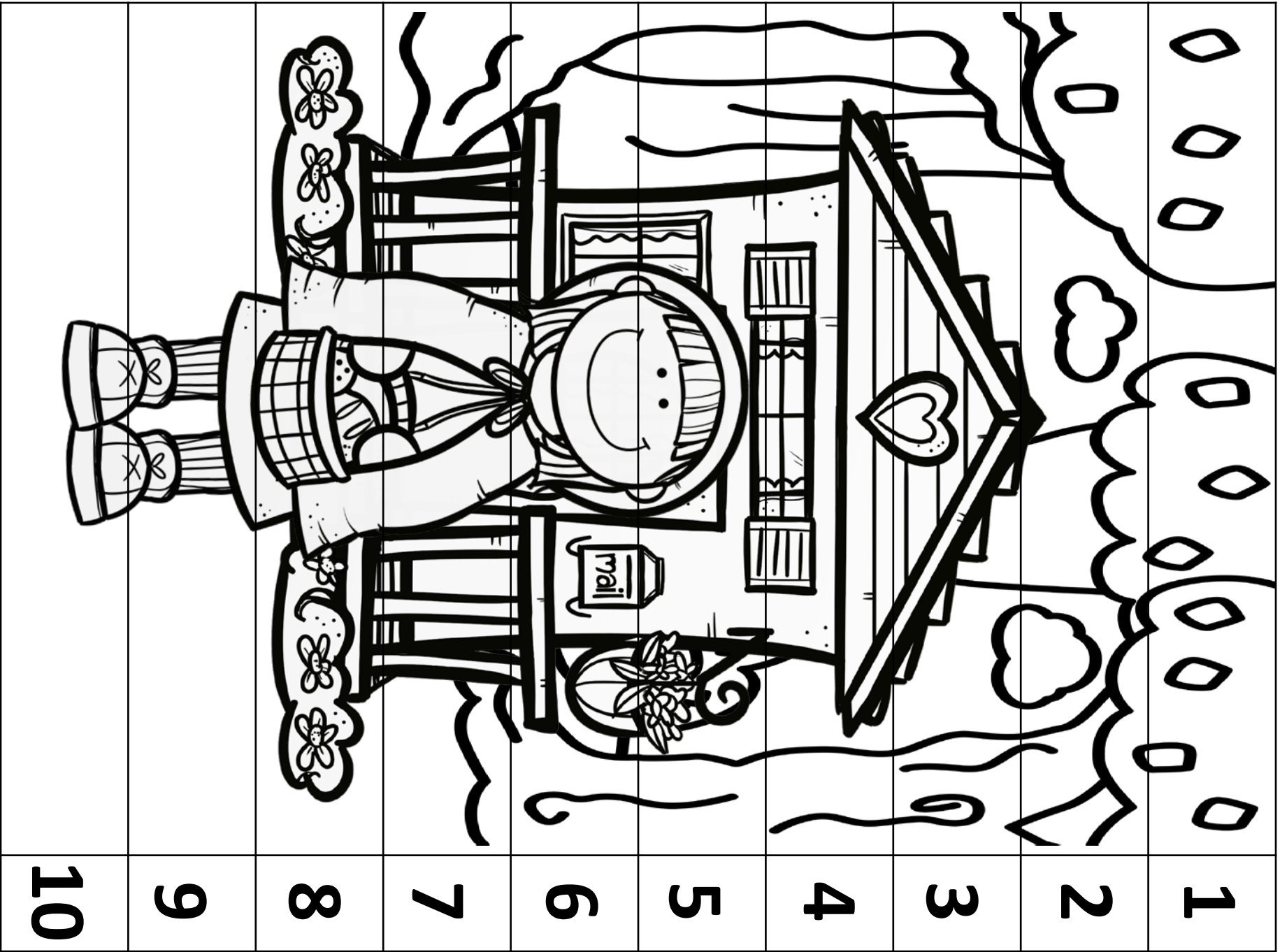

1

2

3

4

5

6

7

8

9

10



10

9

8

7

6

5

4

3

2

1

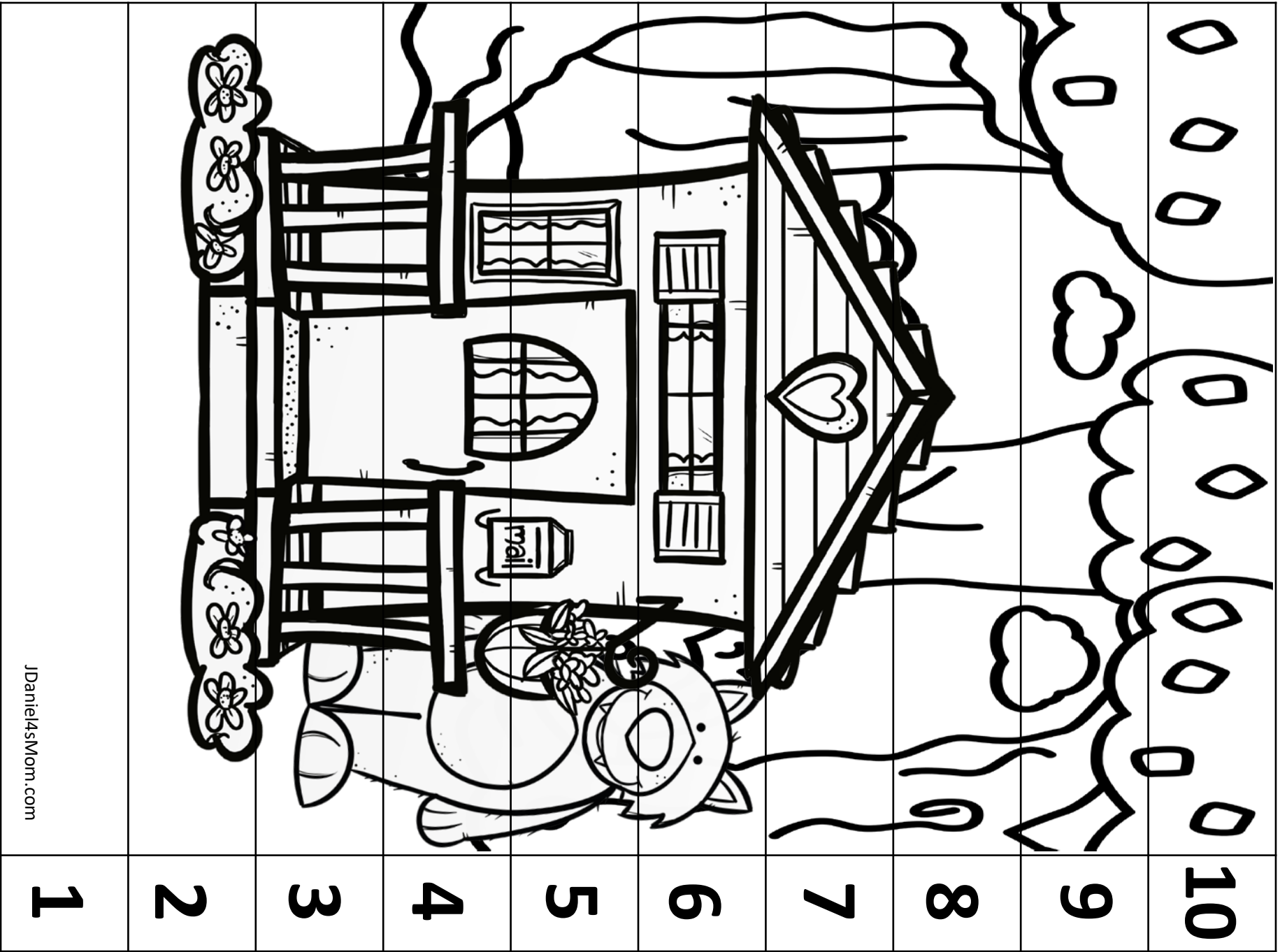

1 2 3 4 5 6 7 8 9 10

1 2 3 4 5 6 7 8 9 10

1 2 3 4 5 6 7 8 9 10

1 2 3 4 5 6 7 8 9 10

1 2 3 4 5 6 7 8 9 10

1 2 3 4 5 6 7 8 9 10

1 2 3 4 5 6 7 8 9 10

1 2 3 4 5 6 7 8 9 10

1 2 3 4 5 6 7 8 9 10

1 2 3 4 5 6 7 8 9 10

1 2 3 4 5 6 7 8 9 10

1 2 3 4 5 6 7 8 9 10

1 2 3 4 5 6 7 8 9 10

1 2 3 4 5 6 7 8 9 10

1 2 3 4 5 6 7 8 9 10

1 2 3 4 5 6 7 8 9 10

1 2 3 4 5 6 7 8 9 10

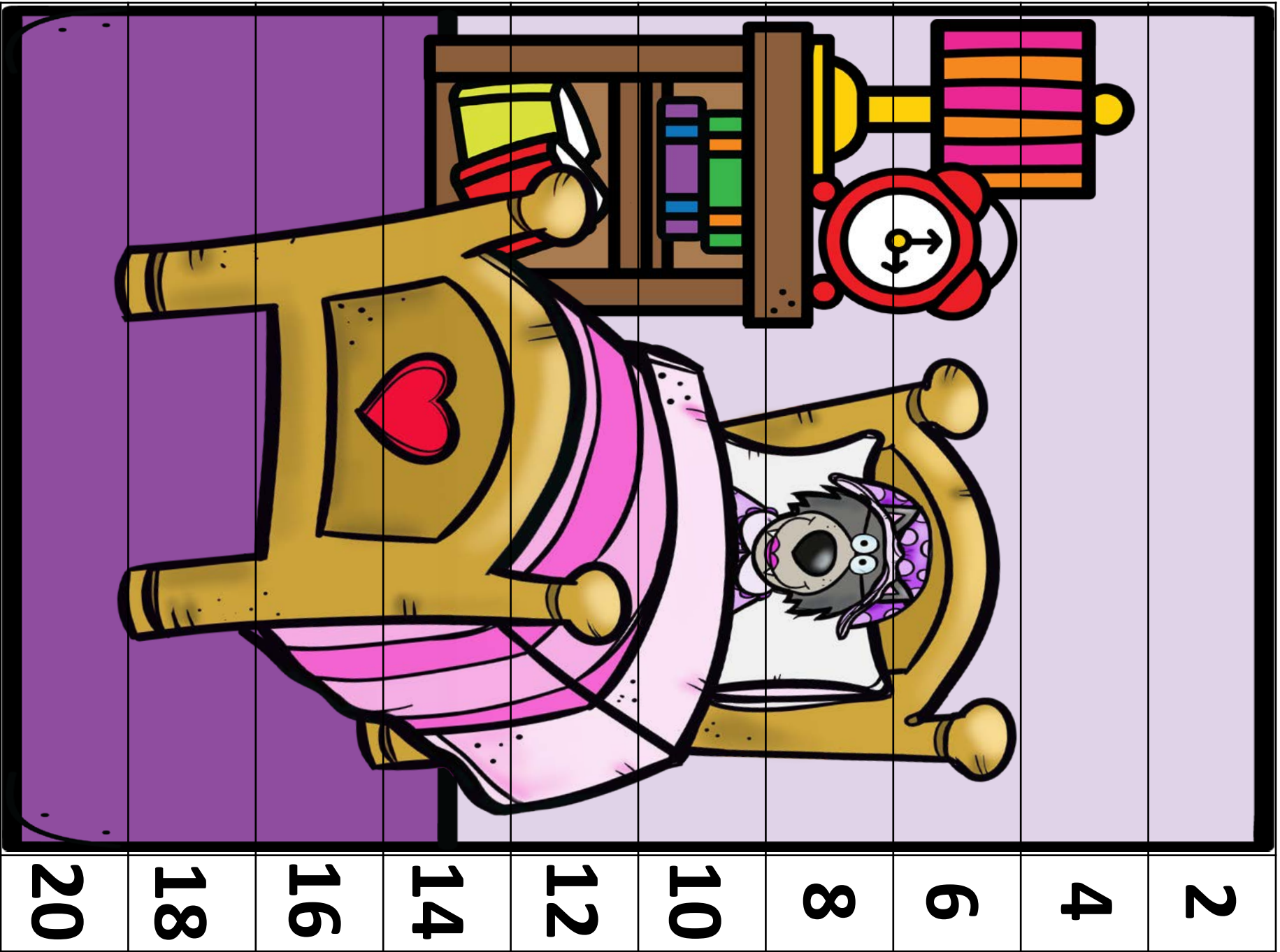

2

4

6

8

10

12

14

16

18

20

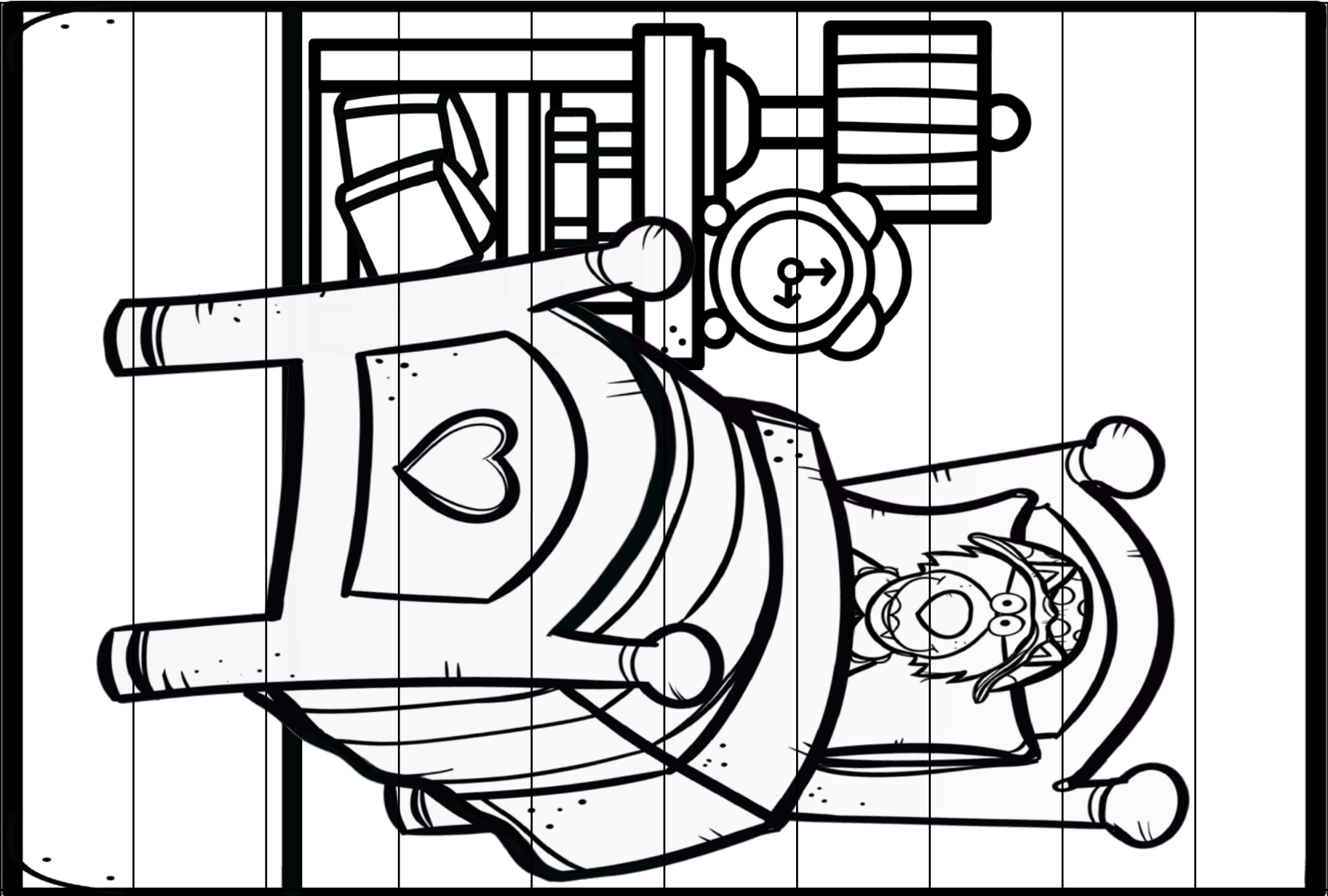

2

4

6

8

10

12

14

16

18

20

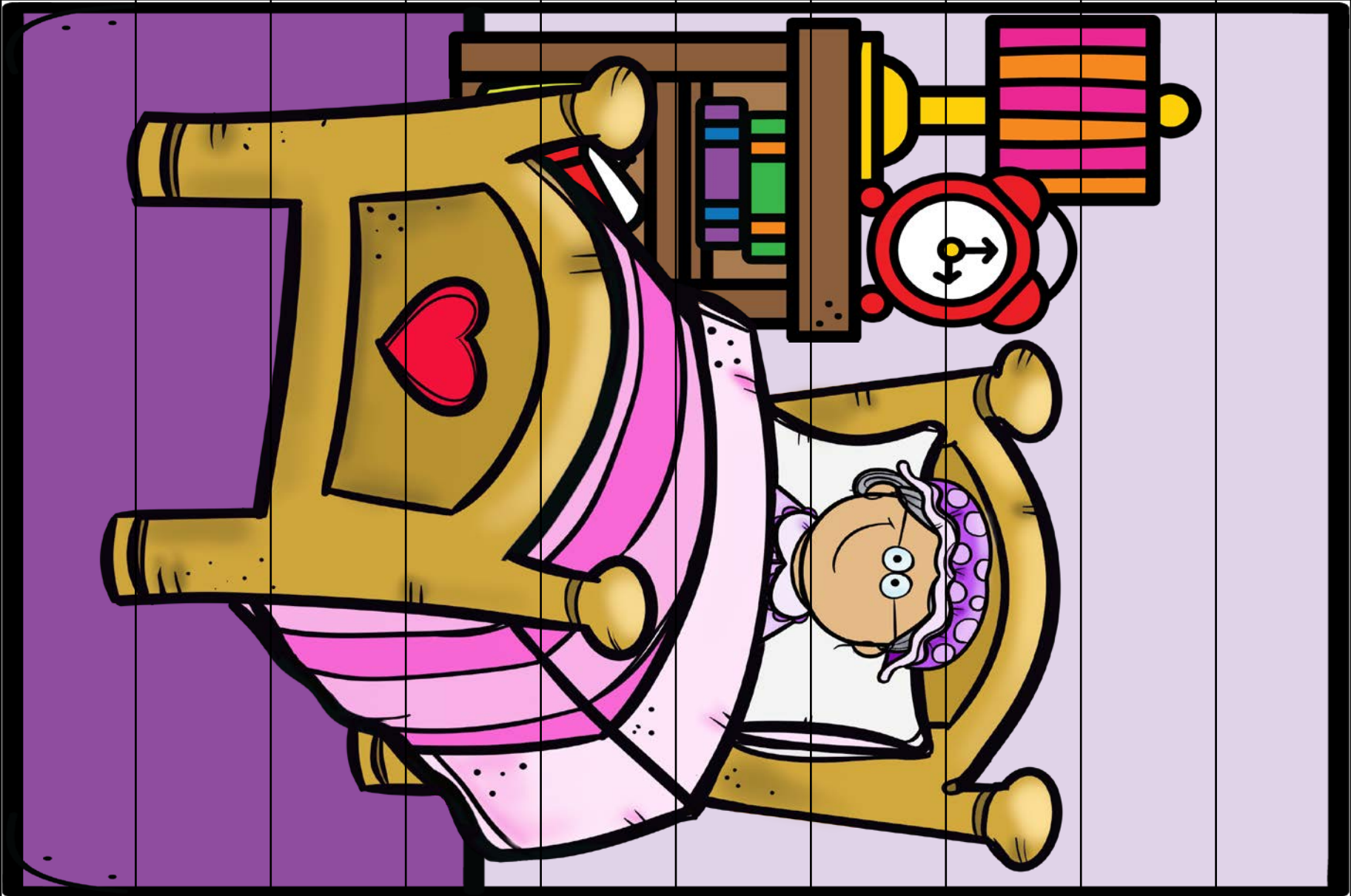

2

4

6

8

10

12

14

16

18

20



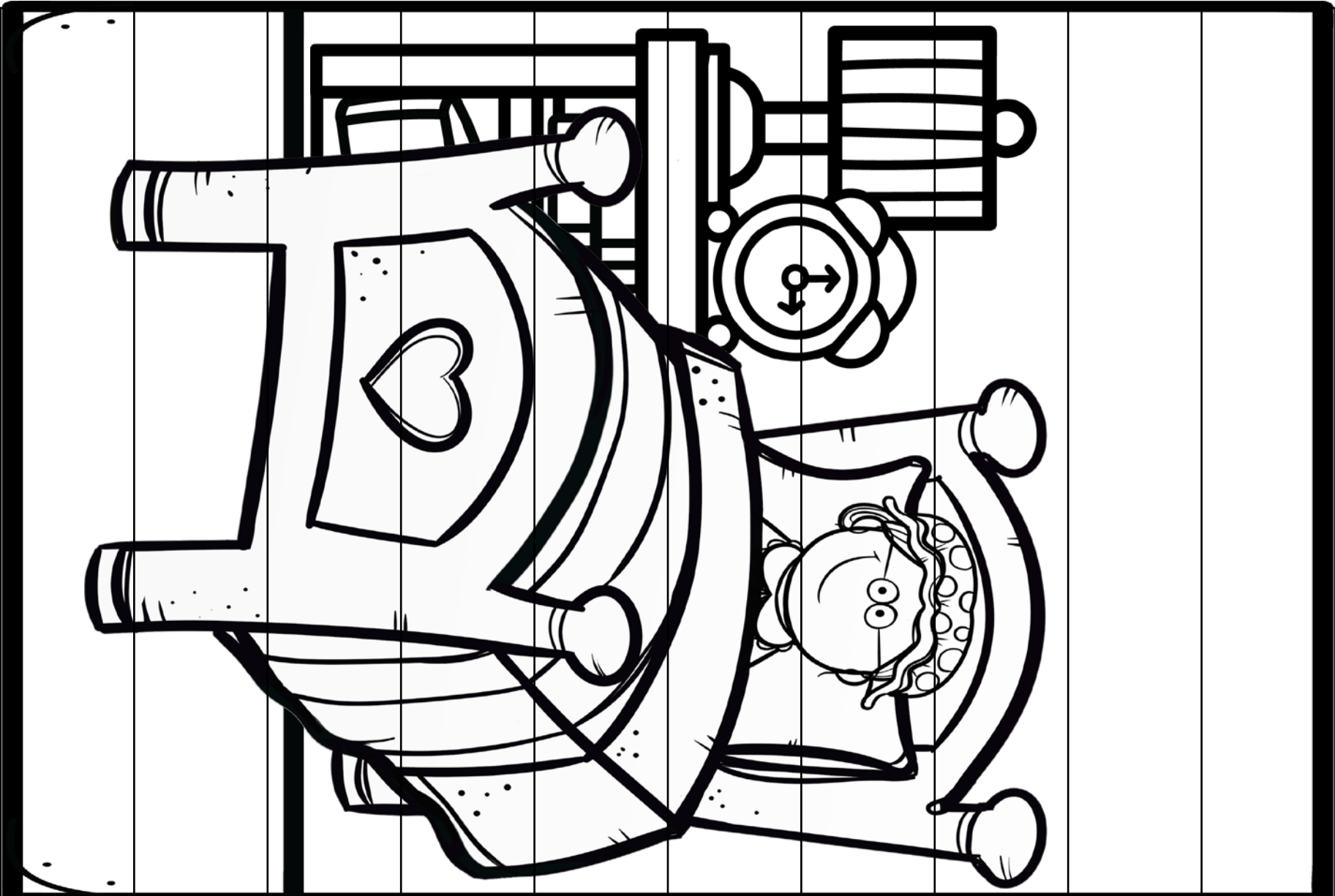

2

4

6

8

10

12

14

16

18

20



1



2

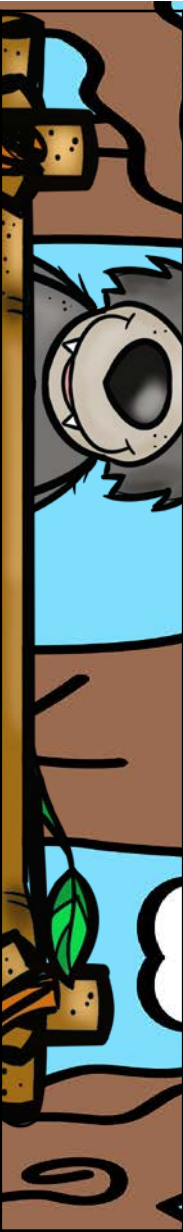

3



4



5



6

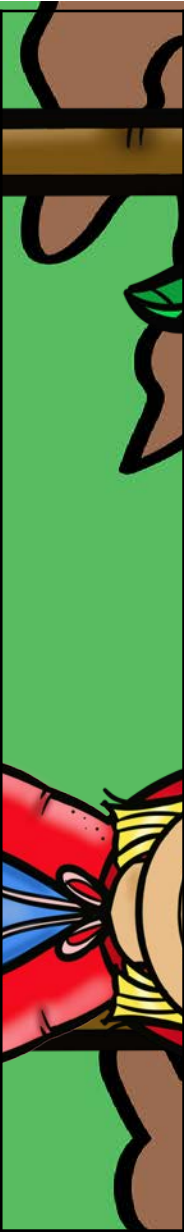

7

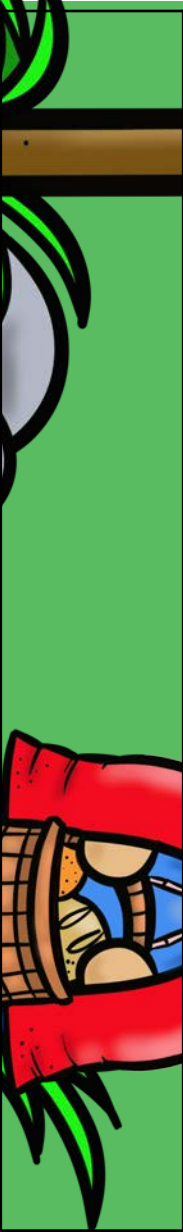

8



9

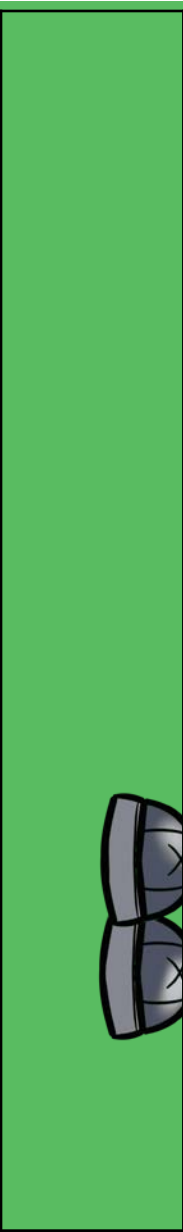

10

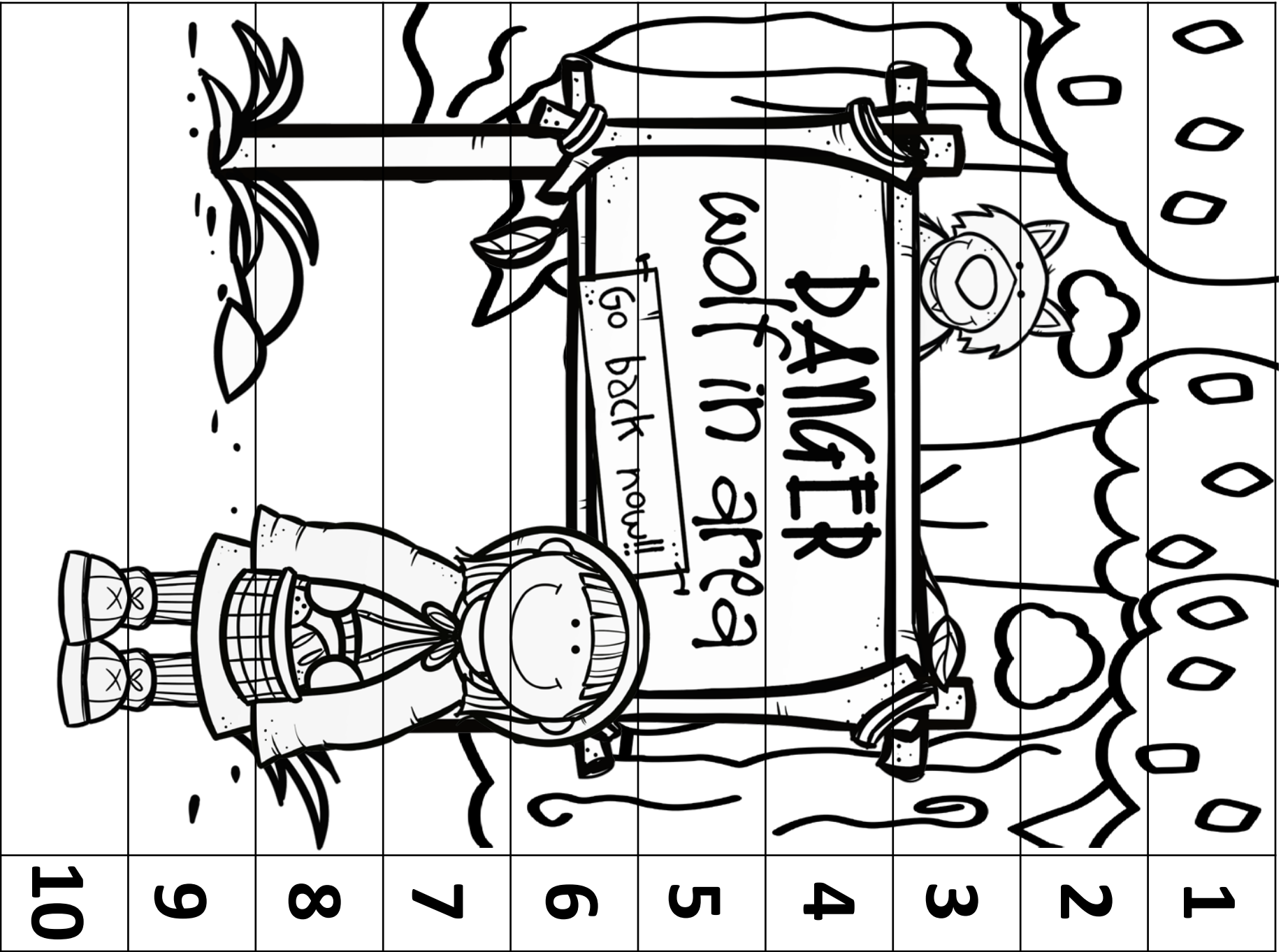

0 0 0

0 0 0

0 0 0

0 0

1

2

3

4

5

6

7

8

9

10

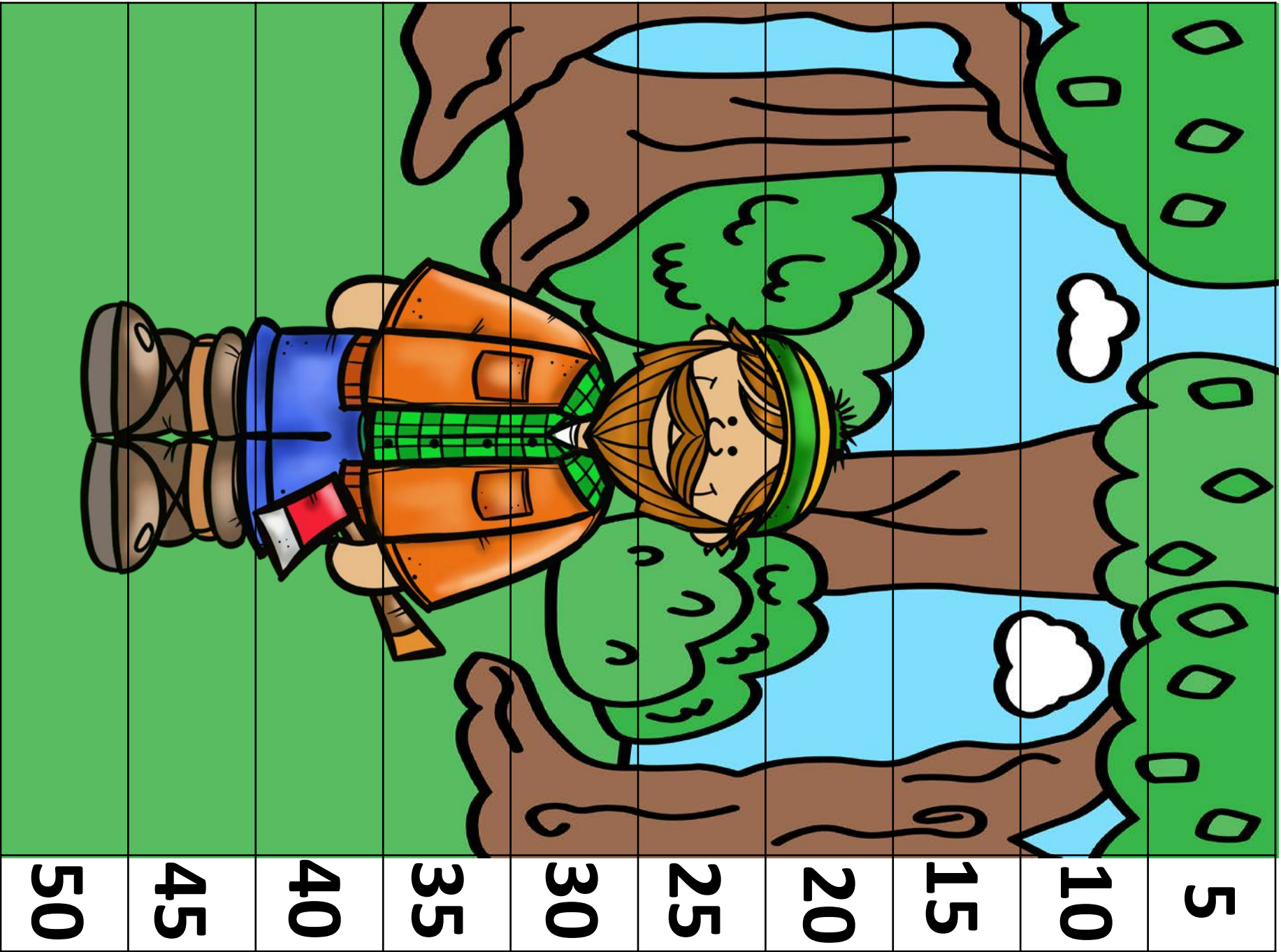

5

10

15

20

25

30

35

40

45

50

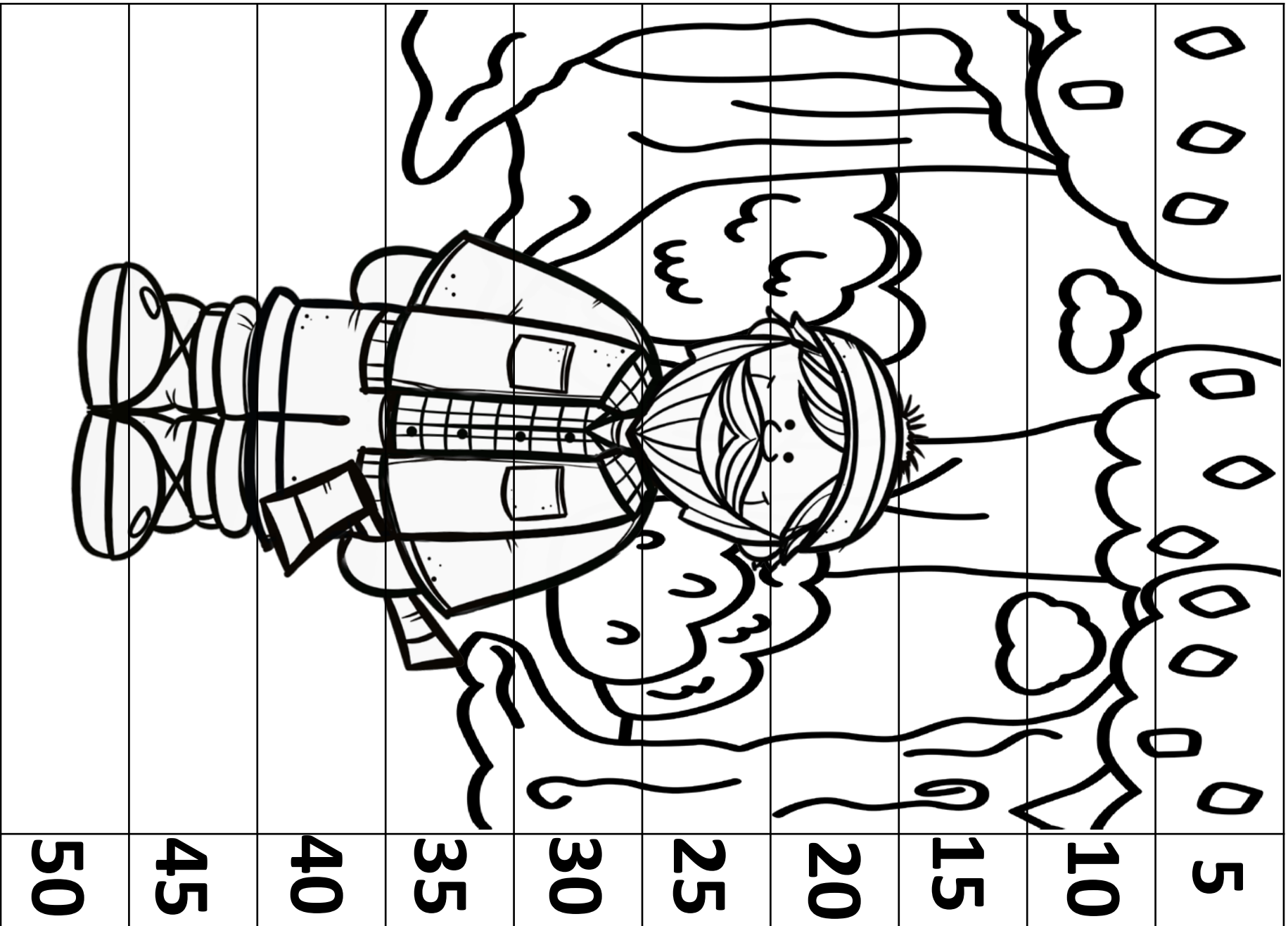

5

10

15

20

25

30

35

40

45

50



Thank you for downloading this set.  
I hope your children enjoy this JDaniel4's Mom resource.

You will find updates on my latest tools on the following:

Instagram: <https://www.instagram.com/jdaniel4smom>

Facebook: <https://www.facebook.com/jdaniel4smom/>

Twitter: <https://twitter.com/jdaniel4smom?lang=en>

Pinterest: <https://www.pinterest.com/jdaniel4smom>

**What is in the set?**

**. Number Puzzles in Color and Black and White**

**Clip Art is From:**

